

FX Pocket Chronograph

Specifications

Size: 72x70x42mm (2.75" x 2.75" x 1.7")

Weight: 133g (5 oz)

Interface: Bluetooth

Smart App: iOS & Android

App name: FX Radar

Measurement Tech: Doppler Radar

Velocity Range: < 335m/s (1099fps)

Power Source: 3x AAA Batteries

Mount: V-shaped mount (not in the picture) that allows you to mount the chrono to the barrel.

Quick Start

1. OVERVIEW

The power button for the chronograph is located on the backside of the device. Next to the power button, you will find two LED lights. The red LED indicates that the batteries should be changed soon, and the green LED indicates that the chronograph is turned on.

To turn on the chronograph, tap the power button. To turn it off, press and hold the power button. The chronograph will automatically shut down after a period of inactivity to save power.

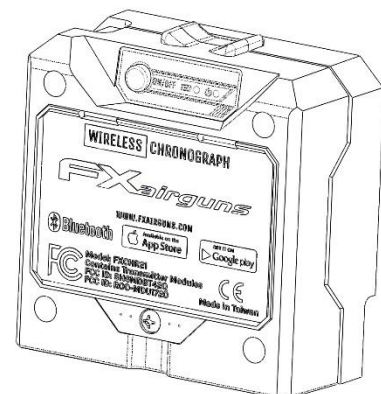

2. BATTERY

Open the battery cover using a screwdriver and insert 3 AAA batteries. Recommended battery type is **Energizer Ultimate Lithium**. Be careful not to overtighten the screw when closing the battery cover.

The plastic is strong enough that the screw can be tightened many times without stripping the threads.

3. ATTACHING THE CHRONOGRAPH TO THE BARREL

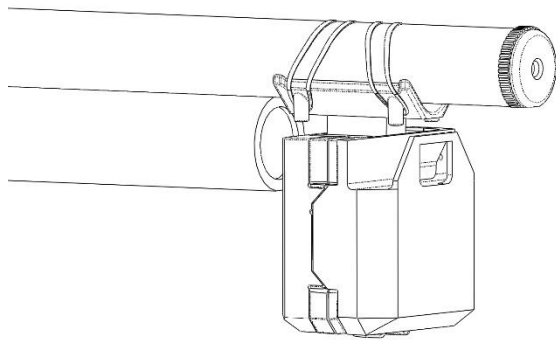

Use elastic bands to attach the chronograph to the barrel.

The optimal placement is a few inches behind the muzzle (a good starting point is between 2-10 inches).

Moving the chronograph further away from the muzzle can sometimes improve its

performance, even though it may seem counterintuitive. The performance of the chronograph improves when it is positioned further away from the muzzle because this reduces the cosine error, which can affect the accuracy of the readings. Cosine error is a type of error that can arise when measuring the velocity of projectiles with radar technology, and it is caused by the angle at which the radar beam hits the projectile. By positioning the chronograph further away from the muzzle, you can reduce the cosine error and improve the accuracy of the readings.

It is important to avoid placing the radar away from the barrel on a table or other surface. This can increase the angle between the chronograph and the projectile's trajectory, which can lead to inaccurate readings. Instead, try to position the chronograph as close to the barrel as possible to reduce the angle and improve the accuracy of the readings.

If you are using a **chronograph mount** (sold separately), try to position it as close to the barrel as possible.



It is important not to place other devices, such as other velocity chronographs, in front of the radar when using the chronograph. This can interfere with the accuracy of the readings.

4. Download the FX Radar App from Google Play Store or Apple App Store.

- a. Before launching the app, ensure that your phone's Bluetooth is turned on. **Do not use pairing in the phone's Bluetooth settings!** The app will manage the pairing with devices.
- b. Launch the app and follow the quick start guide.

The FX Radar App does not require access to your location, but it may be necessary to have location services enabled on your device in order to use it. This is because Bluetooth Low Energy (BLE) technology, which is commonly used in modern smart devices, may require location services to be enabled in order to function properly. BLE is often used for location-based services, such as indoor positioning or beacon technology, and therefore the device needs to be able to determine its location in order to communicate with nearby BLE devices and provide the appropriate location-based services.

- c. **Select a default profile** that best fits your needs or to create a new one, click "Add Profile". The most important thing when using the chronograph is to select a profile with a velocity range that matches your airgun. Velocity range can be changed in settings when custom profile is selected. If you're not sure which setting to choose, try selecting Airgun High Power. This is a good starting point for most users.
- d. **Turn on the chronograph and click the connect button** on the app when it flashes.

When you are connecting to a new device, the app will prompt you to pair with it. Click OK to proceed. If you want to pair with a new device, you do not have to unpair the old one first. The app will manage everything for you.

- e. You are now **ready** to shoot.
- f. **It is important not to place other devices, such as other velocity chronographs, in front of the radar when using the chronograph.** This can interfere with the accuracy of the readings.

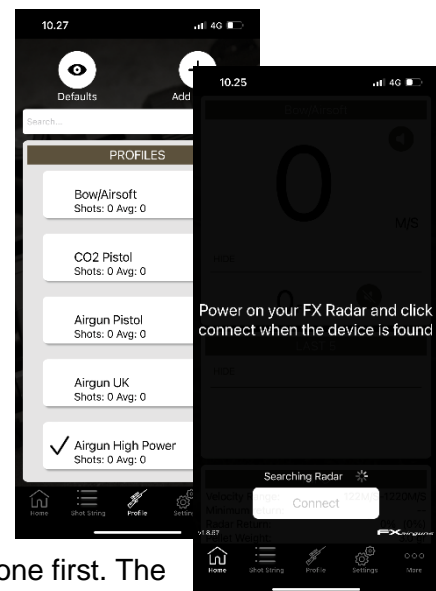

FX Radar App

Android v1.6.112 or newer, iOS v1.8.67 or newer

HOME PAGE

1. When the chronograph is not connected, the home menu will be black and will show a message indicating that it is waiting for a connection. Once you tap the "Connect" button, the display will switch to the "Connected" view. This view is divided into three parts.

In rare cases, the app may not be able to find the chronograph. If this happens, try closing the app completely and restarting it. This should fix the problem.

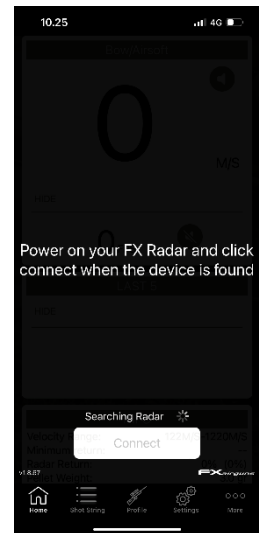

2. The **top section** of the "Connected" view shows the velocity in two different units, with a speaker icon next to each unit to indicate whether the primary or secondary unit is currently selected for voice output. You can turn the voice output on and off by clicking the speaker icon.

The top and middle sections of the "Connected" view can be minimized by clicking the "HIDE" button. This will collapse the sections, allowing you to see more of the bottom section. To expand the sections again, click the "EXPEND" button.

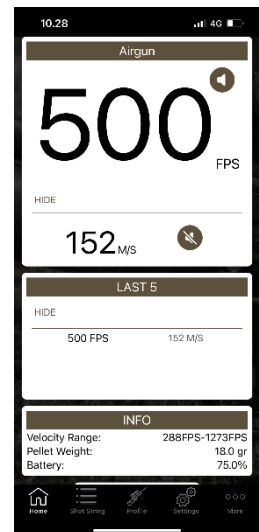

3. The **middle section** of the view displays the velocities of the five most recent shots.
4. The **bottom section** shows the chronograph's battery level and current settings i.e. velocity range.

The **"Disconnect"** button is located below the bottom section of the "Connected" view (it is not visible in the screenshot). When you are finished using the chronograph, you can disconnect the app by clicking this button. The app will also automatically disconnect if the chronograph is turned off.

SHOT STRING PAGE

1. The "Shot String" menu shows a summary of all shots in the current string.

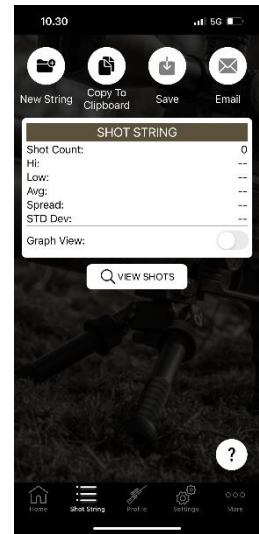

2. At the top of the view, there are options to start a new string, copy the current string to the clipboard, save the string, and email the string.

Saved strings can be accessed in the "More" menu.

3. To view a detailed list of all shots in the string, click "View Shots". If the "Graph View" switch is enabled, the shots will be displayed in a graphical format.
4. To delete individual shots on the "View Shots" view, swipe left on them.

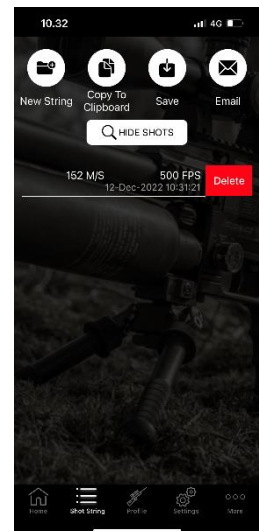

PROFILE PAGE

1. **To select a profile**, go to the profile menu and click on the desired profile. You can edit the name of the profile in the settings menu unless it is a default profile. If you set a name for the pellet in the settings menu, this information will be displayed after the profile name. It is recommended to have a separate profile for each type of pellet that you use.

If you change the profile while you are still connected to the chronograph, the device will be disconnected and you will need to reconnect on the home view. This is because the app is designed to work with a specific profile, and changing the profile will require disconnecting and reconnecting to ensure that the correct settings are used.

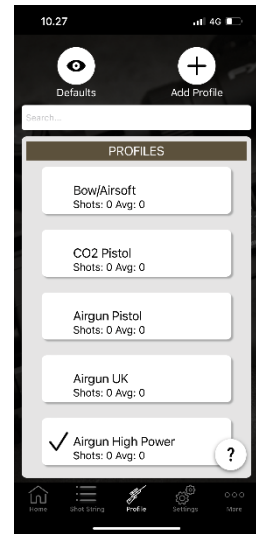

2. To quickly find a profile when the list is long, use the **search bar** in the profile menu. This will allow you to search for the profile by name.

3. **To delete custom profiles**, swipe left on the profile in the profile menu and click "Delete". **To quickly edit** the profile and pellet name or pellet weight, click "Edit".

To make a copy of a profile, swipe right.

This can be useful if you want to create a new profile with similar settings to an existing profile, but with some changes.

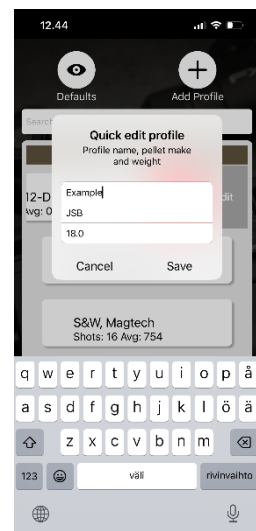
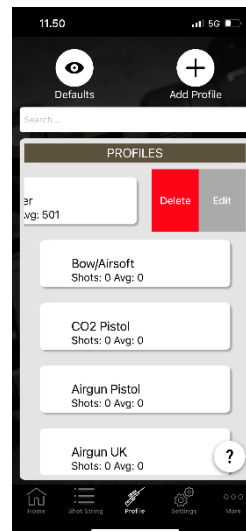

SETTINGS PAGE

1. The settings menu has a segmented control at the top of the view that allows you to switch between "**Profile Settings**" and "**Application Settings**". The "Application Settings" section contains settings that are applied to all profiles, such as the units of measurement. The "Profile Settings" section contains settings that are specific to the currently selected profile, such as the velocity range.

The **profile name** is located in the "General" section of the settings. You can open the "General" settings section by clicking the "GENERAL" button.

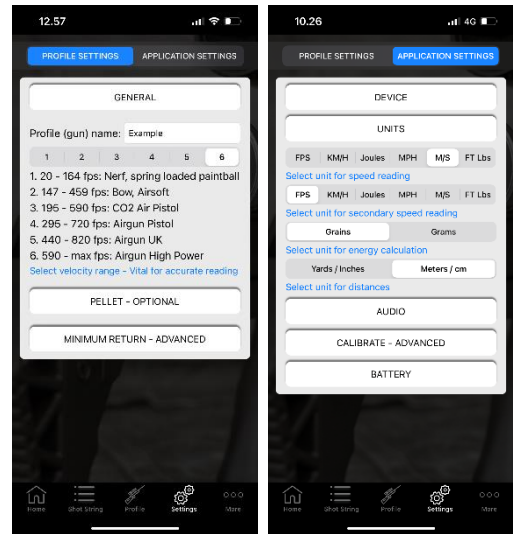

Below the profile name, you will find the **velocity range setting**. It is important to choose a range that best matches your airgun. This will ensure that the chronograph provides accurate readings.

2. The "Pellet" section of the settings is optional. If you choose to enter the make of the pellet, this information will be displayed next to the profile name in the profile list. It is recommended to have a separate profile for each type of pellet that you use.

The weight of the pellet is important for accurate energy calculations. Be sure to enter the correct weight for the pellet you are using.

The unit of measurement for pellet weight can be changed from grains to grams in the "Application Settings" section of the settings. This setting applies to all profiles and will affect the unit of measurement used for pellet weight in all profiles.

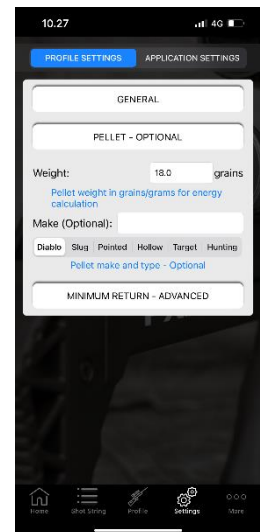

3. The "Minimum Return" setting in the "Advanced" section of the settings is rarely needed. In some cases, the sensitivity of the chronograph may need to be adjusted. If a shot is not being registered, you can try lowering the minimum return value to make the chronograph more sensitive. If the chronograph is reading random values, you can try increasing the minimum return value.

Before making adjustments to the settings, try repositioning the chronograph first. Sometimes moving the chronograph further away from the muzzle can improve its performance, even though it may seem counterintuitive. If repositioning the chronograph does not help, then you can consider making adjustments to the settings.

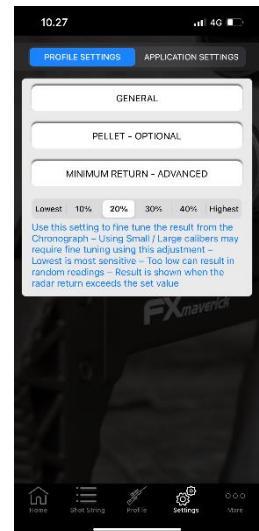

1. In the "Units" section of the settings, you can select the measurement unit for the primary and secondary readings. The weight unit can be set to either grains or grams, and this is used for energy calculations. The distance unit can be set to either yards or meters. These settings apply to all profiles and affect the units of measurement used in all profiles.

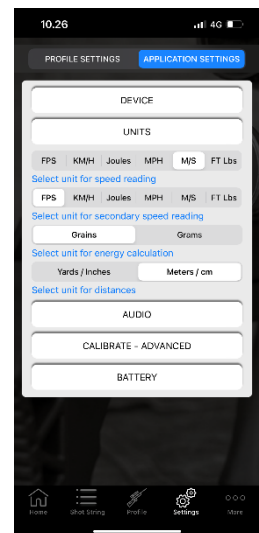

2. In the "Audio" settings, you can enable voice output for the primary and secondary readings. This will cause the app to speak the readings out loud, allowing you to hear them without having to look at the screen. To activate voice output for the primary or secondary readings, simply toggle the switch next to the corresponding reading.

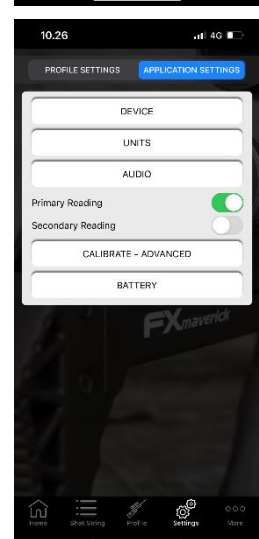

3. In the "Calibrate" settings, you can increase or decrease the readings by a certain percentage. This can be useful when you want to match the readings from the chronograph with those from another velocity chronograph. Please note that this does not mean that the unit requires manual calibration. The percentage adjustment is simply a way to fine-tune the readings to match those from another chronograph, if desired.

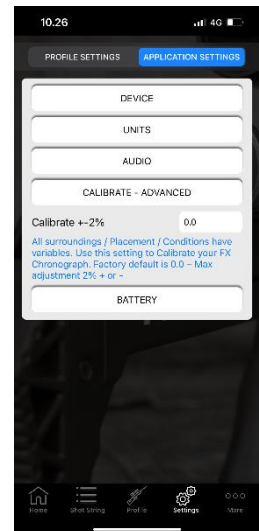

4. In the "Battery" settings, you can choose between two types of batteries to make the battery level indicator work correctly. This is because the voltage level of lithium batteries is much higher than that of alkaline batteries, and the app needs to know which type of batteries you are using in order to display the correct battery level.

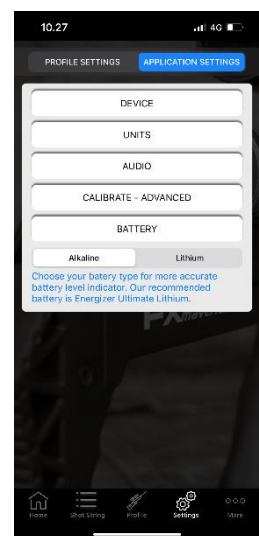

MORE PAGE

1. The "More" menu contains links to the support page, manuals, and quick start guides. To access your saved shot strings, click on "Saved Strings" in the "More" menu. This will open a list of all the saved shot strings, where you can view, copy, email, or delete them as needed.
2. The saved shot strings are grouped by month and year in the "Saved Strings" view. To delete a string, swipe left on it as you would in any other table inside the app.

To open a shot string, simply click on the row. This will open a view where you can edit the shot string name and notes, as well as add an image. Clicking on "Add Image" will allow you to add an image of the shot group, for example.

Clicking on "View String" will take you to the next view, where you can see a detailed list of all the shots in the string. From this view, you can also enable the "Graph View" to see the shots in a graphical format. You can also delete individual shots by swiping left on them.

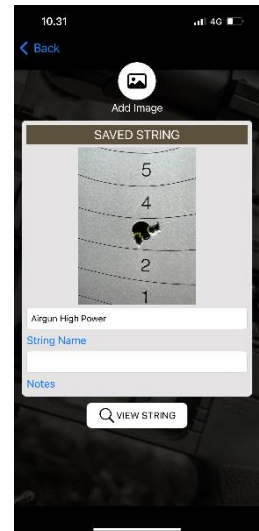

3. The "View String" page has the same options as the "Shot String" page, with one exception. The "View String" page includes a "Copy To Profile" button, which allows you to copy the shots in the saved string to the currently active profile. This will overwrite any existing shots in the active profile.

Other than this, the "View String" page has the same options as the "Shot String" page, including the ability to copy the string to the clipboard, email the string, and view the shots in detail. You can also enable the "Graph View" to see the shots in a graphical format, and delete individual shots by swiping left on them.

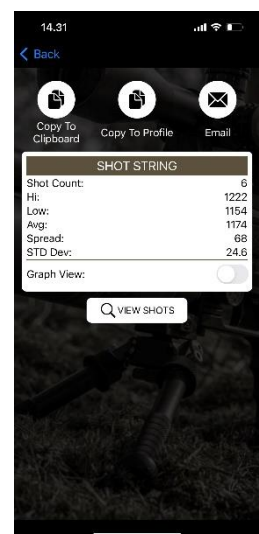

TROUBLESHOOTING

NOT CONNECTING

For Android

Begin by closing and reopening the application. Here's how you can do it:

The steps can slightly vary depending on the version of Android, the brand, and the model of the device, but here is a general guide:

1. Tap the square, recent apps, or app overview icon, which is typically at the bottom of the screen. On some devices, you may need to swipe up from the bottom of the screen or tap a dedicated recent apps button.
2. Find the "FX Radar" app in the list of recent apps. You can usually scroll through the list by swiping left or right or up or down, depending on your device.
3. Swipe the "FX Radar" app off the screen to close it. This usually involves swiping up, but on some devices, you might swipe right or left.

Accessing device settings:

For Android 8.0 (Oreo) and newer: Swipe down from the top of the screen to open the notification shade, and then tap on the gear-shaped Settings icon. Alternatively, open your App Drawer (typically accessed via the button at the center-bottom of the home screen) and locate the 'Settings' app.

For Android 7.0 (Nougat) and older: Depending on the specific device and custom skin from the manufacturer, the 'Settings' app can typically be accessed from the App Drawer, or from a shortcut that is often located on one of the home screens.

For Android versions 6.0 (Marshmallow) to 10 (Q), applications using Bluetooth Low Energy (BLE) also require **location permissions to be granted for proper functioning**. This is because BLE can be used to derive your location by looking at what devices are nearby. This is no longer the case starting with Android 11 (R), which separated Bluetooth and Location permissions.

Here's how you can check your Android version and app permissions:

Checking Android version

1. **Check your Android version:**
2. **Open your device's main Settings app.**
3. **Scroll down and select About phone or About device.** These options might vary depending on your device.
4. **Scroll down to Android version.** The number listed here should be your Android version.

If your Android version is between 6.0 (Marshmallow) to 10 (Q):

1. **Open your device's main Settings app.**
2. **Tap Apps & notifications.**
3. **Tap See all apps or App info.** This will display a list of all applications on your device.
4. **Scroll down and select the "FX Radar".**
5. **Tap Permissions.**
6. **Here, ensure the app has permissions to use Bluetooth and Location.** If a permission is off, tap it, then turn on the switch next to the permission you want to grant.

If your Android version is 11 (R) or above:

1. **Open the 'Settings' menu.** You can do this by swiping down from the top of the screen to reveal the notification panel and clicking on the gear icon, or by locating the 'Settings' app in your app drawer and clicking on it.
2. **Tap Apps & notifications.**
3. **Tap See all apps or App info.**
4. **Scroll down and select the "FX Radar".**
5. **Tap Permissions.**
6. **Here, ensure the app has permissions to use Bluetooth.** If a permission is off, tap it, then turn on the switch next to the permission you want to grant.

If you still have issues with the app, please ensure that your device's operating system and the app are both updated to the latest versions, as this can help solve many common problems.

For iOS

Begin by closing and reopening the application. Here's how you can do it:

1. From the Home screen, swipe up from the bottom of the screen and pause slightly in the middle of the screen. On an iPhone 8 or earlier, double-click the Home button to show your most recently used apps.
2. Swipe right or left to find the "FX Radar" app that you want to close.
3. Swipe up on the app's preview to close the app.

1. **Open the Settings app on your device.**
2. **Scroll down and find the "FX Radar" from the list of apps.**
3. **Tap on the app name to view its permissions.**
4. **Make sure that the Bluetooth permission is toggled on.** If you're using an older version of the app, you might also need to ensure that Location Services is set to "While Using the App" or "Always".

NO AUDIO

For Android

If the audio from your "FX Radar" is not playing correctly, you may want to check the volume settings on your Android device. Here's how:

1. **First, ensure that the audio is enabled within the app.** To do this, navigate to the app settings, select 'Application Settings', and then choose 'Audio'. Either the 'Primary' or 'Secondary' audio should be enabled.
2. **Press the volume button on the side of your device.** This will usually be on the right side of the device.
3. A slider should appear on your screen showing the current volume level. If it's too low or completely muted, increase the volume using the volume up button.
4. If you don't see the volume slider or if pressing the volume buttons doesn't affect the app's volume, you'll need to check the settings. Swipe down from the top of your screen to open the notification shade.
5. Look for a gear icon, which represents the Settings menu, and tap on it.
6. Scroll down and select Sound & vibration.
7. Here, you'll see options for different types of volumes including "Media volume", "Call volume", "Ring volume", and "Alarm volume". Slide the button next to "Media volume" to the right to increase the volume.

Remember that "Media volume" controls the volume for music, videos, games, and other media. Make sure that the volume level is high enough to hear sound from the "FX Radar".

For iOS

If you notice that your device isn't producing any sound, you might want to check the status of this switch. Here's how:

1. **First, ensure that the audio is enabled within the app.** To do this, navigate to the app settings, select 'Application Settings', and then choose 'Audio'. Either the 'Primary' or 'Secondary' audio should be enabled.
2. **Look on the left side of your iOS device, above the volume buttons.** You'll see a small switch.
3. **If the switch is pushed towards the back of the device (showing a red mark), this means your device is in silent mode.** This will mute calls and notifications but doesn't usually affect media and app audio.

4. To turn off silent mode, **flip this switch towards the front of your device** (the screen side). The red mark should no longer be visible.

Please note that the mute switch controls the ringer and alert sounds but doesn't typically mute audio playing from apps or media. However, it's always good to ensure it's not in the silent mode if you're having sound issues.

Once you've turned off silent mode, try adjusting the volume again using the side buttons while the "FX Radar" is open.

1. On the left side of your iOS device, there are two buttons: one for increasing the volume (the one on top), and one for decreasing the volume (the one below).
2. **While you have the "FX Radar" open, press the top button to increase the volume** or the bottom button to decrease the volume. This should adjust the volume of the app directly if you're currently using it.
3. If you press these buttons and the ringer volume indicator appears (it looks like a bell), then your side buttons are currently set to control ringer volume. To change this so that they control your app's volume instead, go to Settings, then Sounds & Haptics, and then turn off the switch next to "Change with Buttons" under the "Ringer and Alerts" section.

Now, when you press the volume buttons while using an app, they should control the app's volume instead of the ringer volume. Remember, the physical buttons will control the volume of sounds and music when apps are in use, but they will control the ringer volume when no apps are actively used or during the lock screen state.

NO READING

Adjusting the distance of the chronograph from the muzzle might enhance its functionality, despite appearing contradictory at first. Experiment by shifting the chronograph various distances from the muzzle. If the chronograph is positioned directly at the muzzle, consider retracting it by approximately 5 inches. Conversely, if the chronograph is considerably distanced from the muzzle, attempt drawing it nearer. **Bear in mind that the chronograph should maintain some distance from the muzzle, yet remain relatively close to the barrel!**

FX*airguns*